

User Manual



MG500

Insulation Tester and Digital Multimeter



Contents

I. Overview.....	1	3. Measuring of CONTINUITY	11
II. OOBA (Out-of-Box Audit).....	1	4. Measuring of Resistance/Capacitance.....	13
III. Safety Operation Criterion.....	2	5. Measuring of Insulation Resistance	15
IV. Electrical Symbols.....	3	6. Polarization Index or Insulation Absorption Ratio	17
V. External Structure.....	4	7. Use of Comparing Function.....	17
VI. LCD.....	5	8. Use of Data Storage Function.....	18
VII. Functions of Keys.....	6	9. Power Supply Tap Position.....	18
1. SAVE/CLEAR.....	6	10. Auto OFF Function.....	18
2. RECALL/ENTER.....	6	IX. Technical Indexes.....	19
3. HOLD/BACKLIGHT.....	6	1. General Specification.....	19
4. COMP/ZERO.....	7	2. Electrical Specification.....	19
5. PI/DAR/SET UP.....	7	3. Technical Indexes.....	20
6. TIMER/LOCK.....	8	X. Maintenance and Repair.....	22
7. TEST.....	8	1. General Maintenance.....	22
8. UP.....	8	2. Battery/Fuse Installation or Replacement	23
9. DOWN/SELECT.....	8	XI. Name of Key Spare Parts.....	24
VIII. Measuring Operation Instructions.....	9		
1. Measuring of AC Voltage.....	9		
2. Measuring of DC Voltage	10		

Insulation Resistance to 200GΩ

Features:

- 50V, 100V, 250V, 500V, and 1000V Test Voltages
- Polarization Index ((PI)
- Dielectric Absorption Rate (DAR)
- Lock Power feature for hands-free operation
- Timed Test function (1 to 10 minutes in 1 minute increments)
- Live circuit voltage indicator
- Comparison (pass/fail) mode
- Leakage current measurement
- AC/DC Voltage, Resistance, Capacitance, Frequency, and Continuity measurement
- Store/Recall 99 measurement groups
- Backlit 6000 count display with bargraph
- Data Hold freezes the reading on the display
- Auto Power off
- Low voltage indicator
- ETL Listed
- Includes test leads, test probes, alligator clips, (6) AA batteries, and carrying case











III. Safety Operation Criterion

The instrument is designed and produced in strict accordance with GB4793 Safety Requirements for Electronic Measuring Apparatus and IEC61010-1, EN 61010-2-030; EN 61010-2-033 safety standards, and complies with the safety standard for double insulation over-voltage CAT IV 600V and pollution level II. Please observe the following operation instruction, otherwise, the instrument provided protection is likely to be weakened or lost.

1. Before using, please check the instrument and probe so as to prevent any damage or abnormal phenomenon. If you find any abnormal situation, such as probe is exposed, shell is damaged, LCD displays nothing or displays in a random way, please don't use the instrument any more. It is prohibited to use uncovered instrument. Otherwise, it is likely to cause hazard of electric shock.
2. If the probe is damaged, it shall be necessary to replace it by probe in the same model or the same electrical specifications.
3. When the instrument is under measuring state, do not touch the exposed wire, connector or circuit without input terminal used or in measuring.
4. When using the instrument to measure DC voltage of higher than 42V or AC voltage of higher than 30V, it is necessary to operate it carefully. Be sure to keep in mind that fingers are not allowed to exceed the position of finger protection, so as to prevent electric shock.
5. Do not apply voltage or current beyond rated voltage or current marked on the instrument between terminals and between any terminal and grounding.
6. In measuring, function switch shall be placed in correct position. Before switch of function switch, it is necessary to cut off connection between probe and measured circuit. It is prohibited to shift tap positions in measuring so as to prevent damage on instrument.
7. Before making online resistance and circuit on/off measuring, it is necessary to cut off all the power supplies in the circuit of the measured device and discharge all the capacitors.
8. Do not store or use the instrument in environment with high-temperature, high-humidity, inflammable, explosive or strong electromagnetic field.

9. Please do not change the internal wiring of the instrument at random, to prevent instrument damage and insecurity.
10. When the symbol of “” is displayed on the LCD, it is necessary to replace the battery timely, so as to assure the measuring accuracy; note: when battery capacity is lower than 7.2V, it will display the symbol of low voltage.
11. After measuring, it is necessary to cut off the power supply in time. It is advised to take out batteries if the instrument is not used for long time.
12. Protection impairment if used in a manner not specified by the manufacturer.
13. Probe assemblies to be used for MAINS measurements shall be RATED as appropriate for CAT IV according to IEC 61010-031 and shall have a voltage RATING of at least the voltage of the circuit to be measured.

IV. Electrical Symbols

	Warning and safety notice
	Double insulation
	DC (direct current)
	AC (alternating current)
	Low battery
	Danger: high voltage
	Fuse
	Grounding
	Meet EU (European Union) standards
	CONFORMS TO UL STD 61010-1, 61010-2-030 and 61010-2-033; CERTIFIED TO CSA STD C22.2 NO.61010-1, 61010-2-030 and IEC STD 61010-2-033
CAT IV	Applicable to test and measuring circuits connected at the source of the building's low-voltage MAINS installation.

V. External Structure (Figure 1)

LCD display area: display of measuring data and functional symbols.

Area of functional keys: selection of basic functions.

Dial switch: selection of measuring function tap positions.

Area for measuring terminals:

1. CONTINUITY jack positive end;
2. CONTINUITY jack negative end;
3. AC/DC voltage, resistance, capacitance measuring and insulation resistance measuring input jack positive end;
4. AC/DC voltage, resistance, capacitance measuring and insulation resistance measuring input jack negative end;

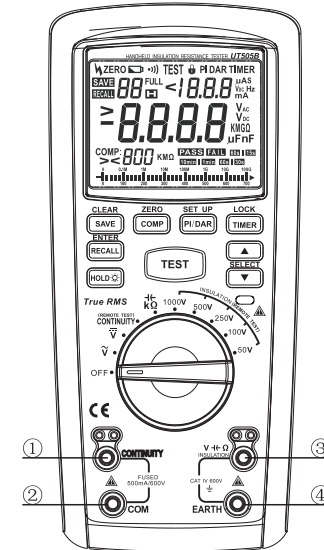

Figure 1

VI. LCD (Figure 2)

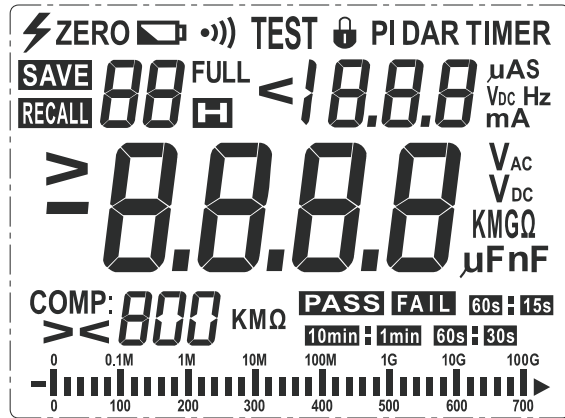

Figure 2

VII. Functions of Keys (See Figure 3)

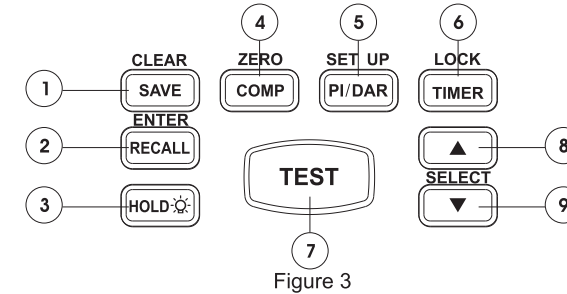

Figure 3

1. SAVE/CLEAR

Click the key of "SAVE/CLEAR" once to save current measuring data (except for RECALL mode); in RECALL mode, hold the key of "SAVE/CLEAR" for about 3 seconds and wait for "-" displayed on the display and all the saved data will have been cleared. After clearing, press RECALL to exit.

2. RECALL/ENTER

Press the key of "RECALL/ENTER" and it will enter RECALL mode and recall the first group of saved data (data have been saved in a certain way). Press the key once again to exit RECALL mode; in SET UP mode, press the key of "RECALL/ENTER" and it will confirm currently set parameters.

3. HOLD/BACKLIGHT

Click "HOLD/" and it will enter reading-hold measuring mode. Click once again and it will exit reading-hold measuring mode (it operates on AC/DC voltage, general resistance and capacitance tap positions only). Hold the key and it will turn on the backlight. When backlight is turned on, it will always be on. If intending to turn off the backlight, it shall be necessary to hold the key.

4. COMP/ZERO

In modes of CONTINUITY and insulation resistance, click the key of "COMP/ZERO" and the function of comparison will be activated. Then click the key and the function will be disabled. In SET UP mode, it is allowed to select different comparing values. In insulation resistance measuring function tap position, comparing values of 500 K Ω , 1 M Ω , 2M Ω , 5M Ω , 10M Ω , 20M Ω , 50M Ω , 100M Ω , 200M Ω and 500M Ω are optional. In CONTINUITY function tap position, comparing values of 1 Ω , 2 Ω , 5 Ω , 10 Ω and 20 Ω are optional. Press the key of ENTER/RECALL to confirm set parameters and hold the key of SETUP to exit. In CONTINUITY short-circuit test, hold the key of "COMP/ZERO" and the zero function will be activated. Hold the key once again and the function will be disabled.

5. PI/DAR/SET UP

The function of "PI/DAR/SET UP" is to start the testing instrument for testing on function of insulation polarization index or dielectric absorption ratio and set relevant parameters in functional tap positions of CONTINUITY and insulation resistance. When there is no test on insulation resistance tap position, click once and the screen will display PI (polarization index) while setting display time ratio to be 10min: 1min; click for the second time and the screen will display DAR (dielectric absorption ratio) while setting time ratio to be 60s: 15s; click for the third time and the screen will display DAR (dielectric absorption ratio) while setting time ratio to be 60s: 30s; click for the fourth time and testing function of PI/DAR (insulation polarization index/dielectric absorption ratio) will be cancelled. Testing can be made by selecting one time ratio required and pressing the testing key. When there is no test in tap positions of insulation resistance and CONTINUITY, hold the key and relevant parameters will be set (press the key of ENTER/RECALL to confirm set parameters). Setting on parameters in function tap position of insulation resistance: ① setting on step voltage: range of setting is 50%-120% of voltage in the function tap position; ② setting on timing ranges from 1min to 10min; ③ setting on comparing values: 500K Ω , 1M Ω , 2M Ω , 5M Ω , 10M Ω , 20M Ω , 50M Ω , 100M Ω , 200M Ω and 500M Ω are optional. Setting on parameters in functional tap position of CONTINUITY: ① setting on measuring current: 20mA/200mA is optional; ② setting on comparing values: 1 Ω , 2 Ω , 5 Ω , 10 Ω and 20 Ω are optional; ③ on/off setting on buzzing function (when comparing function is disabled, testing value shall not be higher

than 30 Ω after buzzing function is activated); in terms of "bu ON" or "bu OFF" displayed on LCD, switch to OFF through UP/DOWN switch and press the key of ENTER to disable the buzzing function. Switch to ON and press the key of ENTER to activate buzzing function. Hold the key of SET UP to exit setting.

6. TIMER/LOCK

When there is no test on insulation resistance tap position, click the key of "TIMER/LOCK" and the timer function will be activated. Then click the key and the function will be disabled. Set in SET UP mode. Timing time can be set to be 1-10min. Hold the key and the lock function will be disabled (the function is activated in booting). Hold the key and the lock function will be activated.

7. TEST

When dial switch is in the position of INSULATION and CONTINUITY, press the key of "TEST" and it will start testing on insulation and continuity. Then press the key and testing will be disabled (when lock function is activated).

8. UP

Press the key of "▲" and there will be the following functions:

Function I: it is used for uplink setting parameters in SET UP mode;

Function II: it is used for uplink retrieval when recalling the saved measured data.

9. DOWN/SELECT

Press the key of "▼/SELECT" and there will be the following functions:

Function I: it is used for downlink setting parameters in SET UP mode;

Function II: it is used for downlink retrieval when recalling the saved measured data;

Function III: it is used for selecting resistance tap position or capacitance tap position in resistance/capacitance;

Function IV: it is used for selecting voltage display or current display (in testing state) in insulation resistance tap position.

VIII. Measuring Operation Instructions

1. Measuring of AC Voltage (See Figure 4)

- ① Insert the red probe into "V" jack (red jack), and black one into "EARTH" jack (black jack).
- ② Rotate dial switch to the tap position of "V~" and connect the probe to both ends of the power supply or load to be tested in parallel.
- ③ Read current measuring values of AC voltage and frequency directly from the display.
- ④ In measuring, if intending to save measured voltage, press the key of "SAVE/CLEAR" for saving.

⚠ Caution:

- Do not input voltage of higher than AC 600V. It is possible to measure higher voltage, but at the risk of meter damage.
- It is especially necessary to be cautious about electric shock when measuring high voltage. If necessary, please wear insulation gloves.
- After connecting all the measuring operations, please be sure to disconnect probe from the tested circuit.

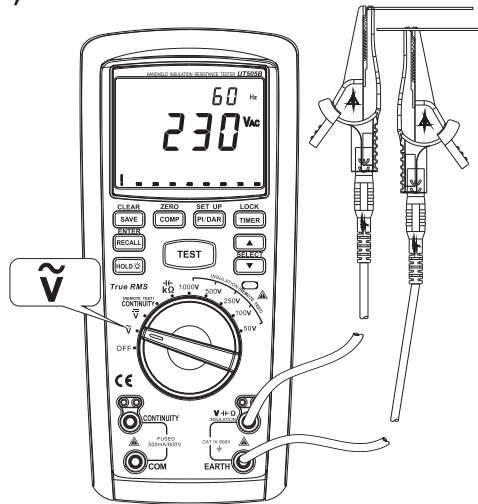

Figure 4

2. Measuring of DC Voltage (See Figure 5)

- ① Insert the red probe into "V" jack (red jack), and black one into "EARTH" jack (black jack).
- ② Rotate dial switch to the tap position of "V-" and connect the probe to both ends of the power supply or load to be tested in parallel.
- ③ Read current measuring values of DC voltage from the display.
- ④ In measuring, if intending to save measured voltage, press the key of "SAVE/CLEAR" for saving.

⚠ Caution:

- Do not input voltage of higher than DC 600V. It is possible to measure higher voltage, but at the risk of meter damage.
- It is especially necessary to be cautious about electric shock when measuring high voltage. If necessary, please wear insulation gloves.
- After connecting all the measuring operations, please be sure to disconnect probe from the tested circuit.

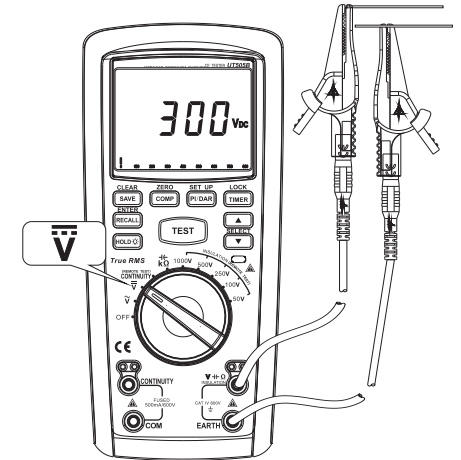

Figure 5

3. Measuring of CONTINUITY (See Figure 6)

- ① Insert the red probe into “CONTINUITY” jack (red jack), and black one into “COM” jack (black jack).
- ② Rotate dial switch to “CONTINUITY” tap position and connect the probe to the circuit tested in parallel.
- ③ Press the key of “TEST” and measured value will be displayed on the display.
- ④ In measuring, if intending to save measured voltage, press the key of “SAVE/CLEAR” for saving.
- ⑤ In order to guarantee measuring accuracy, it is necessary to reset the instrument probe before measuring, which is aimed at eliminating error from the probe; specifically, short-circuit the alligator clips of two probes, press the key of “TEST” and display reading will be resistance of lower than 2.00Ω . Hold “COMP/ZERO” for 3s and symbol of “ZERO” will be displayed on the top left corner of the display and display reading will be “ 0.00Ω ”, indicating zero success. In the test, if fuse loses efficacy, instrument display will display warning character of “FU FAIL” and stop testing, which reminds users that fuse has failed, and fuse shall be replaced before reusing.
- ⑥ If intending to activate buzzing function (when testing value is not higher than 30Ω , buzzer will give out long ring), please set in SET UP function. When LCD displays “bu ON” or “bu OFF”, switch to OFF with UP/DOWN key and press ENTER to disable the buzzing function. Switch to ON and press ENTER to activate buzzing function. When using buzzing function, please be sure that comparing function is disabled.

⚠ Caution:

- Before measuring, ensure that the object to be tested is not electrified. Otherwise, it is likely to result in instrument damage or electric shock.
- Before testing, the instrument will make judgment on whether the tested object is electrified with voltage of higher than about 2V. If the tested object is electrified with voltage of higher than 2V, display will show the symbol of “UE HI FAIL” and measuring will be inhibited.
- When resistance is beyond maximum display range, instrument display will show the symbol of “ $> 100\Omega$ ”.

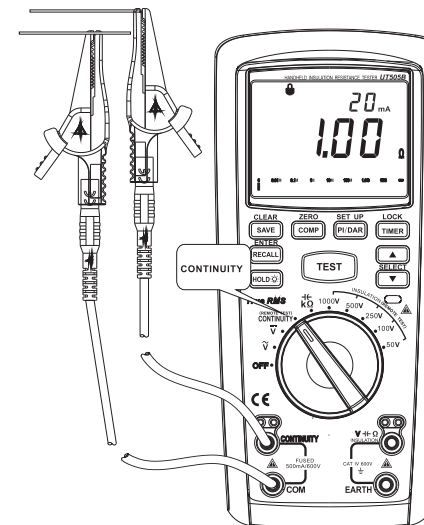

Figure 6

4. Measuring of Resistance/Capacitance

4.1 Measuring of Resistance (See Figure 7)

- ① Insert the red probe into “V” jack (red jack), and black one into “EARTH” jack (black jack).
- ② Rotate dial switch to “KΩ/” tap position and connect the probe to two ends of tested resistance in parallel.
- ③ Read current measuring value of resistance from the display.
- ④ In measuring, if intending to save measured resistance, press the key of “SAVE/CLEAR” for saving.

⚠ Caution:

When measuring on-line resistance, it is necessary to cut off the power supply before measuring.

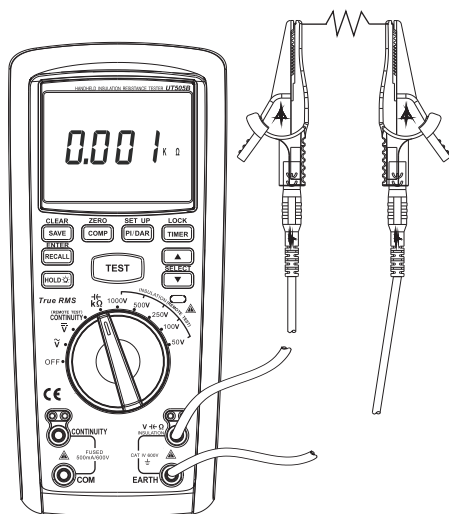

Figure 7

4.2 Measuring of Capacitance (See Figure 8)

- ① Insert the red probe into “V” jack (red jack), and black one into “EARTH” jack (black jack).
- ② Rotate dial switch to “KΩ/” tap position and connect the probe to two ends of tested capacitance in parallel.
- ③ Press “▼/SELECT” to select capacitance tap position.
- ④ Read current measuring value of capacitance from the display.
- ⑤ In measuring, if intending to save measured capacitance, press the key of “SAVE/CLEAR” for saving.

⚠ Caution:

Before measuring capacitance, it is necessary to discharge the capacitor.

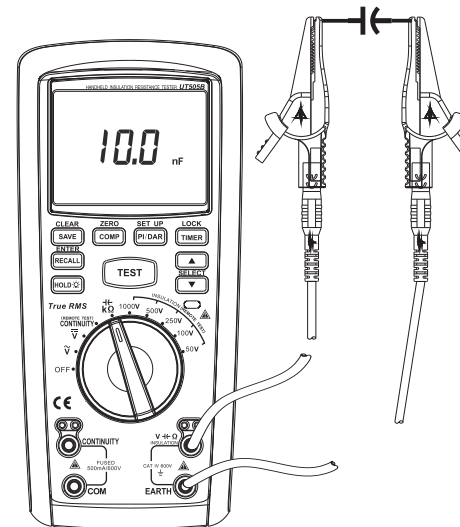

Figure 8

5. Measuring of Insulation Resistance (See Figure 9)

- ① Insert the red probe into "V" jack (red jack), and black one into "EARTH" jack (black jack).
- ② Rotate dial switch to INSUATION (area of insulation resistance) and select the tested voltage required.
Connect the probe to the tested circuit in parallel.
- ③ Press "TEST" on instrument or "TEST" on remote-control probe and read current resistance on main display area on display. In auxiliary display area, tested voltage or current (press "▼" to select) can be seen, while display will flicker and show the warning symbol of high voltage "⚡".
- ④ Press the key of "TEST" and LCD will flicker and show the warning symbol of high voltage "⚡" in case of high-voltage output. In addition, red warning indicator beside warning symbol of shell will be on.
- ⑤ In measuring, if intending to save measuring value, press the key of "SAVE" for saving.

⚠ Caution:

- Before measuring, ensure that the object to be tested is not electrified. Otherwise, measuring is likely to be inaccurate.
- Before measuring, the instrument will make judgment on whether the tested object is electrified with voltage of higher than about 50V. If tested object is electrified with voltage of higher than 50V, display will show the symbol of high voltage and measuring will be inhibited.
- When resistance is beyond maximum display range, instrument display will show the symbol of ">" and maximum resistance in current range.

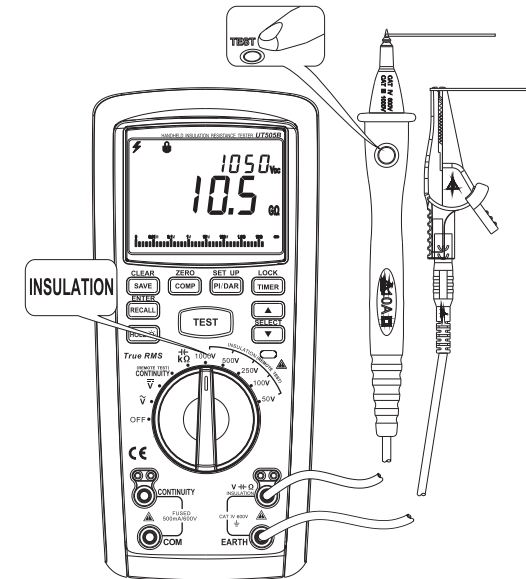

Figure 9

6. Polarization Index or Insulation Absorption Ratio (See Figure 9)

Similar to measuring insulation resistance, it is accessible only by setting polarization index or dielectric absorption ratio; set testing instrument by the key of "PI/DAR/SET UP" to test insulation polarization index or dielectric absorption ratio. When there is no test on insulation resistance tap position, click once and the screen will show PI (polarization index) while setting display time ratio to be 10min: 1min; click for the second time and the screen will show DAR (dielectric absorption ratio) while setting time ratio to be 60s: 15s; click for the third time and the screen will show DAR (dielectric absorption ratio) while setting time ratio to be 60s: 30s; click for the fourth time and testing function of PI/DAR (insulation polarization index/dielectric absorption ratio) will be cancelled. Test can be made by selecting one time ratio required and pressing the key.

7. Use of Comparing Function

In modes of CONTINUITY and insulation resistance, click the key of "COMP/ZERO" and the function of comparison will be activated. Then click the key and the function will be disabled. In SET UP mode, it is allowed to select different comparing values. For function tap positions for insulation resistance measuring, comparing values of 500 K Ω , 1 M Ω , 2M Ω , 5M Ω , 10M Ω , 20M Ω , 50M Ω , 100M Ω , 200M Ω and 500M Ω are optional. For CONTINUITY function tap positions, comparing values of 1 Ω , 2 Ω , 5 Ω , 10 Ω and 20 Ω are optional. Press the key of ENTER/RCALL to confirm the set parameters and hold the key of SETUP to exit. After comparing mode is activated, comparing values and comparing results will be shown on the display. Comparing results are displayed as PASS or FAIL. If it is FAIL, there will be alarm sound.

8. Use of Data Storage Function

- ① Save measuring values: in measuring, press the key of "SAVE/CLEAR" to save current measuring values with 1 group added to saved articles on the display. A total of 99 groups are allowed to be added at most;
- ② Recall measuring values: press the key of "RECALL/ENTER" to enter mode of data recall and press "UP/DOWN" to check data saved.
- ③ Clear measured data in memory: press the key of "RECALL" to enter mode of data recall, hold the key of "SAVE/CLEAR" for 3s and wait for "-" to be displayed on the display, indicating that all the data saved have been cleared.

9. Power Supply Tap Position

When knob switch is placed at the position of "OFF", power supply will be switched off.

10. Auto OFF Function

Where there is no operation to knob switch or keys within 10min, the LCD will be faded and the instrument will enter micro-power consumption sleep state. If intending to wake up the instrument for operation, it shall be necessary to re-place the knob switch to the position of "OFF" and at a certain measuring tap positions. Then, the instrument will be wakened up.

IX. Technical Indexes

1. General Specification

- Display: liquid crystal display with maximum display reading of up to 9999;
- Low-battery warning: see Table 1;
- Over-range indicator: mark of “>” appears on tap positions of insulation resistance and CONTINUITY;
- Function of automatic range;
- Unit display: display of symbols for functions and power unit;
- Operating conditions: 0°C-40°C/relative humidity of 85% or lower;
- Storing conditions: -20°C-60°C/relative humidity of 90% or lower;
- Dimensions: mm (225L)×mm (103W)×mm (59D);
- Current consumption: about 500mA (1000V at maximum in output) (about 17mA in normal state);
- The instrument is designed and produced in strict accordance with IEC61010 safety standard, and complies with the safety standards for over-voltage (CAT IV 600V) and pollution level II;
- Function of automatic voltage release;
- Backlight function is convenient for operation in dark light;
- Red warning indicator;
- Altitude: ≤2,000m;
- Accessories: private wire, alligator clip, 6 1.5V (No.5) alkaline batteries, instructions and a carrying bag;
- Weight: 0.7kg (with batteries).
- Compliance Standards: EN61010-1:2010 ; EN61010-2-030:2010 ; EN61010-2-033:2012 ; EN61557-1:2007 ; EN61557-2:2007 ; EN61557-4:2007 ; EN61326-1:2013 ; EN61326-2-2:2013

2. Electrical Specification

Error limit: ± (a% reading + b word count), calibration period is a year;
 Ambient temperature: 23°C ± 5°C;
 Ambient humidity: 45-75%RH; Temperature coefficient: 0.1×(accuracy)/°C;

3. Technical Indexes (See Table 2)

1. Measuring of AC voltage:

Measurement Range	Minimum Resolution	Range of Valid Frequency in Accuracy: 45Hz-450Hz
0~600V	0.01V	±(1.5%+5)

When measured voltage frequency >450Hz, measuring values shall serve as reference only.

2. Measuring of Frequency (Auxiliary Display of AC Voltage Tap position):

Measurement Range	Minimum Resolution	Range of Valid Frequency in Accuracy: 45Hz-450Hz
45~1KHz	0.1Hz	±(0.1%+3)

3. Measuring of DC Voltage:

Measurement Range	Minimum Resolution	Accuracy
-600~600V	0.01V	±(2%+3)

4. Measuring of CONTINUITY:

Measured Current	Measurement Range	Minimum Resolution	Accuracy
20mA	0.01 Ω~100Ω	0.01Ω	±(1.5%+5)
200mA	0.01 Ω~10Ω	0.01Ω	±(1.5%+4)

In open circuit, measured voltage is about 5V.

5. Measuring of Resistance:

Measurement Range	Minimum Resolution	Accuracy
0.001K Ω ~10M Ω	0.001K Ω	$\pm(3\%+3)$

6. Measuring of Capacitance:

Measurement Range	Minimum Resolution	Accuracy
0.1nF~500 μ F	0.1nF	$\pm(5\%+5)$

7. Measuring Insulation Resistance:

Output Voltage	Measurement Range	Minimum Resolution	Accuracy
50V (0~+20%)	0.00M Ω ~0.99G Ω	0.01M Ω	$\pm(3\%+3)$
	1.00G Ω ~10.0G Ω	0.01G Ω	$\pm(3\%+3)$ Reading $\pm 4\%/G\Omega$
100V (0~+20%)	0.00M Ω ~0.99G Ω	0.01M Ω	$\pm(3\%+3)$
	1.00G Ω ~20.0G Ω	0.01G Ω	$\pm(3\%+3)$ Reading $\pm 2\%/G\Omega$
250V (0~+20%)	0.00M Ω ~0.99G Ω	0.01M Ω	$\pm(3\%+3)$
	1.00G Ω ~50G Ω	0.01G Ω	$\pm(3\%+3)$ Reading $\pm 0.8\%/G\Omega$
500V (0~+20%)	0.00M Ω ~0.99G Ω	0.01M Ω	$\pm(3\%+3)$
	1.00G Ω ~100G Ω	0.01G Ω	$\pm(3\%+3)$ Reading $\pm 0.4\%/G\Omega$
1000V (0~+20%)	0.00M Ω ~0.99G Ω	0.01M Ω	$\pm(3\%+3)$
	1.00G Ω ~200G Ω	0.01G Ω	$\pm(3\%+3)$ Reading $\pm 0.2\%/G\Omega$

Operation range for EN61557: 0.10M Ω -1.00G Ω (insulation output voltage ≥ 50 V).

Short-circuit current: <3mA

Testing range for leaked current: 10 μ A to 2mA.

Testing accuracy for leaked current: 10% \pm 3.

Step voltage for insulation output voltage is set to be 50%-120% at the step of 10%.

In measuring insulation resistance, when step voltage selected is lower than nominal voltage in the function tap position (50V/100V/250V/500V/1000V), maximum testing range for insulation resistance will be 1/2 of maximum testing range for the function tap position and accuracy will be added with ± 2 word counts.

X. Maintenance and Repair

Caution:

Before opening the face cover of the instrument, please be sure that power supply has been switched off, and the probe has been away from input terminal and tested circuit.

1. General Maintenance

- Use clean-water wet cloth or sponge to scrub the surface.
- In order to prevent damage on the testing instrument, please do not immerse the instrument in water.
- When instrument is moist, please dry it before storage.
- When it is necessary to check or repair the instrument, please hand over the instrument to qualified professional maintenance staff members or specified maintenance departments for repair.

2. Battery/Fuse Installation or Replacement (See Figure 10)

The power supply for this product is 6 1.5V (No.5) batteries. Please install or replace batteries according to the sequence listed in Figure 10.

- ① Turn knob switch to the position of OFF (off) and remove private wire.
- ② Use standard cross screwdriver to remove three screws on the battery cover, remove the battery cover, take out batteries and install new batteries according to the polar indication.
- ③ Please use batteries in the same model. Do not install any inappropriate battery.
- ④ Please take out damaged fuse in the way shown in Figure 10 and replace it with fuse in the same specifications. Fuse specifications: 0.5A/1000V.
- ⑤ After installing new batteries, install battery cover and screw three screws.

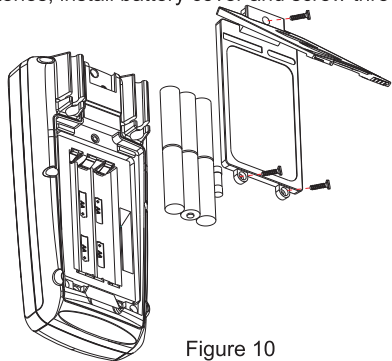

Figure 10

Warranty

Triplett / Jewell Instruments extends the following warranty to the original purchaser of these goods for use. Triplett warrants to the original purchaser for use that the products sold by it will be free from defects in workmanship and material for a period of (2) two years from the date of purchase. This warranty does not apply to any of our products which have been repaired or altered by unauthorized persons in any way or purchased from unauthorized distributors so as, in our sole judgment, to injure their stability or reliability, or which have been subject to misuse, abuse, misapplication, negligence, accident or which have had the serial numbers altered, defaced, or removed. Accessories, including batteries are not covered by this warranty.

**Copyright © 2023 Triplett
www.triplett.com**